



Flushbutton
NP8-□□BN/□

P03



Projecting button
NP8-□□GN/□

P04



Mushroom button,
self-reset
NP8-□□M/□

P05



Mushroom button, self-locking,
rotate to reset
NP8-□□ZS/□□

P07



Illuminated mushroom
button, self-reset
NP8-□□MD/□□

P06



Illuminated double-
head button
NP8-□□SD

P08



Selector switch
NP8-□□×/□□

P09



Illuminated Selector
switch
NP8-□□×D/□

P11



Key switch
NP8-□ Y/□□

P11



Double-head button
NP8-□□S

P08



Illuminated flush button
NP8-□□BND/□

P03



Illuminated projecting
button
NP8-□□GND/□

P04



Indicator light
NP8-D/□

P09



NP8 22mm Pushbutton Compound Models

1. General information

Electric ratings: AC50/60Hz, AC415V/DC250V;
 Degree of protection: IP54
 Standard: IEC/EN60947-5-1

2. Working & mounting conditions

- 2.1 Ambient temperature is $-5^{\circ}\text{C} \sim +40^{\circ}\text{C}$, the average temperature during 24 hours couldn't exceed $+35^{\circ}\text{C}$.
- 2.2 Altitude: $\leq 2000\text{m}$.
- 2.3 Atmosphere condition: Relative humidity of the atmosphere couldn't exceed 50% when the highest temperature is $+40^{\circ}\text{C}$; much higher relative humidity is allowable under the condition of lower temperature, for example, when the temperature reaches $+20^{\circ}\text{C}$, the relative humidity is up to 90%. As for dews, which contingently appear due to change of temperature, special steps should be taken.
- 2.4 Pollution grade: 3
- 2.5 Installation category: II

3. Technical data

3.1 Refer to table below for rated values related to utilization category.

AC-15	Rated operational voltage, V	415	240	120
	Rated operational current, A	1.9	3	6
DC-13	Rated operational voltage, V	250	125	-
	Rated operational current, A	0.27	0.55	-

3.2 Refer to table 3 for basic parameters of illuminated pushbutton.

Basic parameters	LED lamp
Rated operational current	$\leq 20\text{mA}$
Rated operational voltage	AC/DC 6V, 12V, 24V, 36V, AC110V~230V

3.3 Durability

Mechanical life:

Flush, mushroom-headed and illuminated version:
 3×10^6 operation circles.

Rotary, double-headed, self-locking and keyed version:
 1×10^5 operation circles.

Electric life:

Flush, mushroom-headed and illuminated version:
 AC 1×10^5 / DC 2.5×10^5 operation circles.



Rotary, double-headed, self-locking and key type button:
 1×10^5 operation circles.

4. Features

- 4.1 Operating mechanism features
 bright colors and streamline surface.
- 4.2 Modular design.
 Operating system, adapter, contact system and illuminating system can be freely combined to realize different functions.
- 4.3 Convenient for mounting and dismounting thanks to snap-on structure.
- 4.4 Automatic locking function of the central adaptor makes it convenient and reliable for mounting and connection.
- 4.5 The terminal screw is available with anti-loosing mechanism to protect it against loosening from the body during transportation.
- 4.6 LED lamp with high brightness and long service life ensures reliable indication.

5. NP8 pushbutton

★ Momentary Flush Pushbutton-(Non illuminated)





NP8-□□ BN/ □□	Model	Color	⏏	⏏
	NP8-10BN/1	○	1	—
	NP8-10BN/2	●	1	—
	NP8-10BN/3	●	1	—
	NP8-10BN/4	●	1	—
	NP8-10BN/5	●	1	—
	NP8-10BN/6	●	1	—
	NP8-01BN/1	○	—	1
	NP8-01BN/2	●	—	1
	NP8-01BN/3	●	—	1
	NP8-01BN/4	●	—	1
	NP8-01BN/5	●	—	1
	NP8-01BN/6	●	—	1
	NP8-20BN/1	○	2	—
	NP8-20BN/2	●	2	—
	NP8-20BN/3	●	2	—
	NP8-20BN/4	●	2	—
	NP8-20BN/5	●	2	—
	NP8-20BN/6	●	2	—
	NP8-02BN/1	○	—	2
	NP8-02BN/2	●	—	2
	NP8-02BN/3	●	—	2
	NP8-02BN/4	●	—	2
	NP8-02BN/5	●	—	2
	NP8-02BN/6	●	—	2
	NP8-11BN/1	○	1	1
	NP8-11BN/2	●	1	1
	NP8-11BN/3	●	1	1
	NP8-11BN/4	●	1	1
	NP8-11BN/5	●	1	1
	NP8-11BN/6	●	1	1

★ Momentary Flush Pushbutton-illuminated AC/DC6V, 12V, 24V, 36V, AC110V~230V

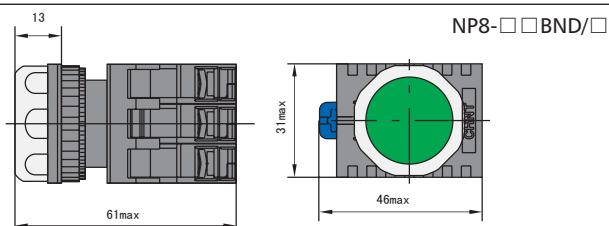
NP8-□□ BND/ □□	Model	Color	⏏	⏏
	NP8-10BND/1	○	1	—
	NP8-10BND/3	●	1	—
	NP8-10BND/4	●	1	—
	NP8-10BND/5	●	1	—
	NP8-10BND/6	●	1	—
	NP8-01BND/1	○	—	1
	NP8-01BND/3	●	—	1
	NP8-01BND/4	●	—	1
	NP8-01BND/5	●	—	1
	NP8-01BND/6	●	—	1



Dimension (mm)

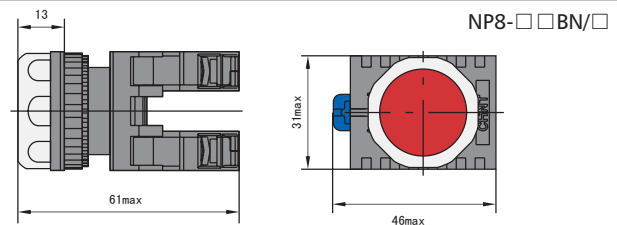

NP8-□□ BN/ □□	Model	Color	⏏	⏏
	NP8-30BN/1	○	3	—
	NP8-30BN/2	●	3	—
	NP8-30BN/3	●	3	—
	NP8-30BN/4	●	3	—
	NP8-30BN/5	●	3	—
	NP8-30BN/6	●	3	—
	NP8-03BN/1	○	—	3
	NP8-03BN/2	●	—	3
	NP8-03BN/3	●	—	3
	NP8-03BN/4	●	—	3
	NP8-03BN/5	●	—	3
	NP8-03BN/6	●	—	3
	NP8-12BN/1	○	1	2
	NP8-12BN/2	●	1	2
	NP8-12BN/3	●	1	2
	NP8-12BN/4	●	1	2
	NP8-12BN/5	●	1	2
	NP8-12BN/6	●	1	2
	NP8-21BN/1	○	2	1
	NP8-21BN/2	●	2	1
	NP8-21BN/3	●	2	1
	NP8-21BN/4	●	2	1
	NP8-21BN/5	●	2	1
	NP8-21BN/6	●	2	1

Dimension (mm)



NP8-□□ BND/ □□	Model	Color	⏏	⏏	
	NP8-20BND/1	○	2	—	
	NP8-20BND/3	●	2	—	
	NP8-20BND/4	●	2	—	
	NP8-20BND/5	●	2	—	
	NP8-20BND/6	●	2	—	
	NP8-02BND/1	○	—	2	
	NP8-02BND/3	●	—	2	
	NP8-02BND/4	●	—	2	
	NP8-02BND/5	●	—	2	
	NP8-02BND/6	●	—	2	
		NP8-11BND/1	○	1	1
		NP8-11BND/3	●	1	1
NP8-11BND/4		●	1	1	
NP8-11BND/5		●	1	1	
NP8-11BND/6		●	1	1	

★ Momentary Flush Pushbutton-(Non illuminated)

NP8-□□ GN/□□	Model	Color	↵	↶	
	NP8-10GN/1	○	1	—	
	NP8-10GN/2	●	1	—	
	NP8-10GN/3	●	1	—	
	NP8-10GN/4	●	1	—	
	NP8-10GN/5	●	1	—	
	NP8-10GN/6	●	1	—	
	NP8-01GN/1	○	—	1	—
	NP8-01GN/2	●	—	1	—
	NP8-01GN/3	●	—	1	—
	NP8-01GN/4	●	—	1	—
	NP8-01GN/5	●	—	1	—
	NP8-01GN/6	●	—	1	—
	NP8-20GN/1	○	2	—	
	NP8-20GN/2	●	2	—	
	NP8-20GN/3	●	2	—	
	NP8-20GN/4	●	2	—	
	NP8-20GN/5	●	2	—	
	NP8-20GN/6	●	2	—	
	NP8-02GN/1	○	—	2	—
	NP8-02GN/2	●	—	2	—
	NP8-02GN/3	●	—	2	—
	NP8-02GN/4	●	—	2	—
	NP8-02GN/5	●	—	2	—
	NP8-02GN/6	●	—	2	—
	NP8-11GN/1	○	1	1	—
	NP8-11GN/2	●	1	1	—
	NP8-11GN/3	●	1	1	—
	NP8-11GN/4	●	1	1	—
	NP8-11GN/5	●	1	1	—
	NP8-11GN/6	●	1	1	—

NP8-□□ GN/□□	Model	Color	↵	↶	
	NP8-30GN/1	○	3	—	
	NP8-30GN/2	●	3	—	
	NP8-30GN/3	●	3	—	
	NP8-30GN/4	●	3	—	
	NP8-30GN/5	●	3	—	
	NP8-30GN/6	●	3	—	
	NP8-03GN/1	○	—	3	—
	NP8-03GN/2	●	—	3	—
	NP8-03GN/3	●	—	3	—
	NP8-30GN/4	●	3	—	—
	NP8-30GN/5	●	3	—	—
	NP8-30GN/6	●	3	—	—
	NP8-03GN/1	○	—	3	—
	NP8-03GN/2	●	—	3	—
	NP8-03GN/3	●	—	3	—
	NP8-03GN/4	●	—	3	—
	NP8-03GN/5	●	—	3	—
	NP8-03GN/6	●	—	3	—
	NP8-12GN/1	○	1	2	—
	NP8-12GN/2	●	1	2	—
	NP8-12GN/3	●	1	2	—
	NP8-12GN/4	●	1	2	—
	NP8-12GN/5	●	1	2	—
	NP8-12GN/6	●	1	2	—
	NP8-21GN/1	○	2	1	—
	NP8-21GN/2	●	2	1	—
	NP8-21GN/3	●	2	1	—
	NP8-21GN/4	●	2	1	—
	NP8-21GN/5	●	2	1	—
	NP8-21GN/6	●	2	1	—

Dimension (mm)

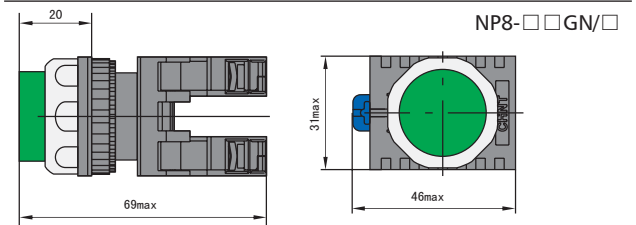

★ Momentary Flush Pushbutton-illuminated
 AC/DC6V, 12V, 24V, 36V, AC110V~230V

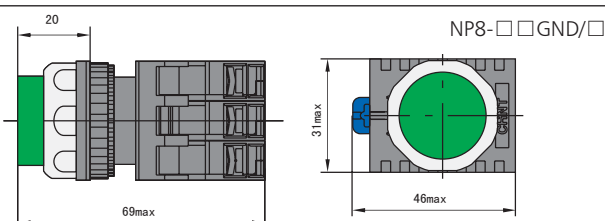

NP8-□□ GND/□□	Model	Color	↵	↶	
	NP8-10GND/1	○	1	—	
	NP8-10GND/3	●	1	—	
	NP8-10GND/4	●	1	—	
	NP8-10GND/5	●	1	—	
	NP8-10GND/6	●	1	—	
	NP8-01GND/1	○	—	1	—
	NP8-01GND/3	●	—	1	—
	NP8-01GND/4	●	—	1	—
	NP8-01GND/5	●	—	1	—
	NP8-01GND/6	●	—	1	—

Dimension (mm)





NP8-□□ GND/□□	Model	Color	↵	↶	
	NP8-20GND/1	○	2	—	
	NP8-20GND/3	●	2	—	
	NP8-20GND/4	●	2	—	
	NP8-20GND/5	●	2	—	
	NP8-20GND/6	●	2	—	
	NP8-02GND/1	○	—	2	—
	NP8-02GND/3	●	—	2	—
	NP8-02GND/4	●	—	2	—
	NP8-02GND/5	●	—	2	—
	NP8-02GND/6	●	—	2	—
	NP8-11GND/1	○	1	1	—
	NP8-11GND/3	●	1	1	—
	NP8-11GND/4	●	1	1	—
	NP8-11GND/5	●	1	1	—
	NP8-11GND/6	●	1	1	—

★ ϕ 40 Momentary Mushroom button-(Non illuminated)

NP8-□□ M/□□	Model	Color	⌋	⌋	
	NP8-10M/11	○	1	—	
	NP8-10M/12	●	1	—	
	NP8-10M/13	●	1	—	
	NP8-10M/14	●	1	—	
	NP8-10M/15	●	1	—	
	NP8-10M/16	●	1	—	
	NP8-01M/11	○	—	1	
	NP8-01M/12	●	—	1	
	NP8-01M/13	●	—	1	
	NP8-01M/14	●	—	1	
	NP8-01M/15	●	—	1	
	NP8-01M/16	●	—	1	
		NP8-20M/11	○	2	—
		NP8-20M/12	●	2	—
		NP8-20M/13	●	2	—
		NP8-20M/14	●	2	—
NP8-20M/15		●	2	—	
NP8-20M/16		●	2	—	
NP8-02M/11		○	—	2	
NP8-02M/12		●	—	2	
NP8-02M/13		●	—	2	
NP8-02M/14		●	—	2	
NP8-02M/15		●	—	2	
NP8-02M/16		●	—	2	
NP8-11M/11		○	1	1	
NP8-11M/12		●	1	1	
NP8-11M/13		●	1	1	
NP8-11M/14		●	1	1	
NP8-11M/15	●	1	1		
NP8-11M/16	●	1	1		
	NP8-30M/11	○	3	—	
	NP8-30M/12	●	3	—	
	NP8-30M/13	●	3	—	
	NP8-30M/14	●	3	—	
	NP8-30M/15	●	3	—	
	NP8-30M/16	●	3	—	
	NP8-03M/11	○	—	3	
	NP8-03M/12	●	—	3	
	NP8-03M/13	●	—	3	

NP8-□□ M/□□	Model	Color	⌋	⌋
	NP8-03M/14	●	—	3
	NP8-03M/15	●	—	3
	NP8-03M/16	●	—	3
	NP8-12M/11	○	1	2
	NP8-12M/12	●	1	2
	NP8-12M/13	●	1	2
	NP8-12M/14	●	1	2
	NP8-12M/15	●	1	2
	NP8-12M/16	●	1	2
	NP8-21M/11	○	2	1
	NP8-21M/12	●	2	1
	NP8-21M/13	●	2	1
	NP8-21M/14	●	2	1
	NP8-21M/15	●	2	1
	NP8-21M/16	●	2	1

★ ϕ 60 Momentary Mushroom button-(Non illuminated)

NP8-□□ M/□□	Model	Color	⌋	⌋	
	NP8-10M/21	○	1	—	
	NP8-10M/22	●	1	—	
	NP8-10M/23	●	1	—	
	NP8-10M/24	●	1	—	
	NP8-10M/25	●	1	—	
	NP8-10M/26	●	1	—	
	NP8-01M/21	○	—	1	
	NP8-01M/22	●	—	1	
	NP8-01M/23	●	—	1	
	NP8-01M/24	●	—	1	
	NP8-01M/25	●	—	1	
	NP8-01M/26	●	—	1	
		NP8-20M/21	○	2	—
		NP8-20M/22	●	2	—
		NP8-20M/23	●	2	—
		NP8-20M/24	●	2	—
NP8-20M/25		●	2	—	
NP8-20M/26		●	2	—	
NP8-02M/21		○	—	2	
NP8-02M/22		●	—	2	

1 CONTACT BLOCK
(Non-illuminated)

NP8-□□ M/□□	Model	Color	⏏	⏏
	NP8-02M/23	Green	—	2
	NP8-02M/24	Red	—	2
	NP8-02M/25	Yellow	—	2
	NP8-02M/26	Blue	—	2
	NP8-11M/21	White	1	1
	NP8-11M/22	Black	1	1
	NP8-11M/23	Green	1	1
	NP8-11M/24	Red	1	1
	NP8-11M/25	Yellow	1	1
	NP8-11M/26	Blue	1	1
	NP8-30M/21	White	3	—
	NP8-30M/22	Black	3	—
NP8-30M/23	Green	3	—	
NP8-30M/24	Red	3	—	
NP8-30M/25	Yellow	3	—	
NP8-30M/26	Blue	3	—	
NP8-03M/21	White	—	3	
NP8-03M/22	Black	—	3	
NP8-03M/23	Green	—	3	
NP8-03M/24	Red	—	3	
NP8-03M/25	Yellow	—	3	
NP8-03M/26	Blue	—	3	
NP8-12M/21	White	1	2	
NP8-12M/22	Black	1	2	
NP8-12M/23	Green	1	2	
NP8-12M/24	Red	1	2	
NP8-12M/25	Yellow	1	2	
NP8-12M/26	Blue	1	2	
NP8-21M/21	White	2	1	
NP8-21M/22	Black	2	1	
NP8-21M/23	Green	2	1	
NP8-21M/24	Red	2	1	
NP8-21M/25	Yellow	2	1	
NP8-21M/26	Blue	2	1	

Dimension (mm)

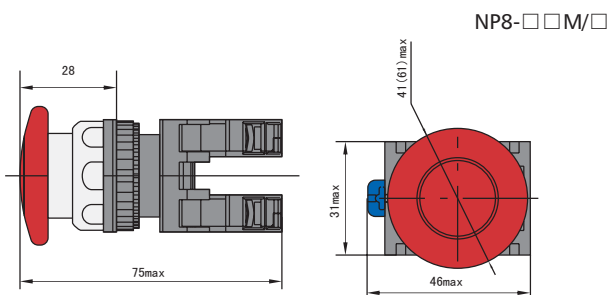

★ ϕ 40 Momentary Mushroom button-illuminated
 AC/DC6V, 12V, 24V, 36V, AC110V~230V

NP8-□□ MD/□□	Model	Color	⏏	⏏
	NP8-10MD/11	White	1	—
	NP8-10MD/13	Green	1	—
	NP8-10MD/14	Red	1	—
	NP8-10MD/15	Yellow	1	—
	NP8-10MD/16	Blue	1	—
	NP8-01MD/11	White	—	1
	NP8-01MD/13	Green	—	1
	NP8-01MD/14	Red	—	1
	NP8-01MD/15	Yellow	—	1
	NP8-01MD/16	Blue	—	1
	NP8-20MD/11	White	2	—
	NP8-20MD/13	Green	2	—
	NP8-20MD/14	Red	2	—
	NP8-20MD/15	Yellow	2	—
	NP8-20MD/16	Blue	2	—
	NP8-02MD/11	White	—	2
NP8-02MD/13	Green	—	2	
NP8-02MD/14	Red	—	2	
NP8-02MD/15	Yellow	—	2	
NP8-02MD/16	Blue	—	2	
NP8-11MD/11	White	1	1	
NP8-11MD/13	Green	1	1	
NP8-11MD/14	Red	1	1	
NP8-11MD/15	Yellow	1	1	
NP8-11MD/16	Blue	1	1	

★ ϕ 60 Momentary Mushroom button-illuminated
 AC/DC6V, 12V, 24V, 36V, AC110V~230V

NP8-□□ MD/□□	Model	Color	⏏	⏏
1 CONTACT BLOCK (Non-illuminated)	NP8-10MD/11	White	1	—
	NP8-10MD/13	Green	1	—
	NP8-10MD/14	Red	1	—
	NP8-10MD/15	Yellow	1	—
	NP8-10MD/16	Blue	1	—
	NP8-01MD/11	White	—	1
	NP8-01MD/13	Green	—	1
	NP8-01MD/14	Red	—	1
	NP8-01MD/15	Yellow	—	1
	NP8-01MD/16	Blue	—	1

NP8-□□ MD/□□	Model	Color	⏏	⏏
2 CONTACT BLOCK (Non-illuminated)	NP8-20MD/11	○	2	—
	NP8-20MD/13	●	2	—
	NP8-20MD/14	●	2	—
	NP8-20MD/15	●	2	—
	NP8-20MD/16	●	2	—
	NP8-02MD/11	○	—	2
	NP8-02MD/13	●	—	2
	NP8-02MD/14	●	—	2
	NP8-02MD/15	●	—	2
	NP8-02MD/16	●	—	2
	NP8-11MD/11	○	1	1
	NP8-11MD/13	●	1	1
	NP8-11MD/14	●	1	1
	NP8-11MD/15	●	1	1
	NP8-11MD/16	●	1	1

Dimension (mm)

NP8-□□MD/□

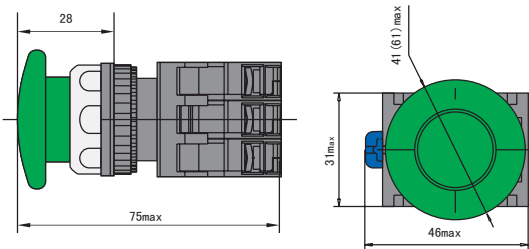



★ φ 40 Mushroom button-(Non illuminated) Maintained

NP8-□□ ZS/□□	Model	Color	⏏	⏏
	NP8-10ZS/11	○	1	—
	NP8-10ZS/12	●	1	—
	NP8-10ZS/13	●	1	—
	NP8-10ZS/14	●	1	—
	NP8-10ZS/15	●	1	—
	NP8-10ZS/16	●	1	—
	NP8-01ZS/11	○	—	1
	NP8-01ZS/12	●	—	1
	NP8-01ZS/13	●	—	1
	NP8-01ZS/14	●	—	1
	NP8-01ZS/15	●	—	1
	NP8-01ZS/16	●	—	1

NP8-□□ ZS/□□	Model	Color	⏏	⏏
	NP8-20ZS/11	○	2	—
	NP8-20ZS/12	●	2	—
	NP8-20ZS/13	●	2	—
	NP8-20ZS/14	●	2	—
	NP8-20ZS/15	●	2	—
	NP8-20ZS/16	●	2	—
	NP8-02ZS/11	○	—	2
	NP8-02ZS/12	●	—	2
	NP8-02ZS/13	●	—	2
	NP8-02ZS/14	●	—	2
	NP8-02ZS/15	●	—	2
	NP8-02ZS/16	●	—	2
	NP8-11ZS/11	○	1	1
	NP8-11ZS/12	●	1	1
	NP8-11ZS/13	●	1	1
	NP8-11ZS/14	●	1	1
NP8-11ZS/15	●	1	1	
NP8-11ZS/16	●	1	1	

★ φ 60 Mushroom button-(Non illuminated) Maintained

NP8-□□ ZS/□□	Model	Color	⏏	⏏
	NP8-10ZS/21	○	1	—
	NP8-10ZS/22	●	1	—
	NP8-10ZS/23	●	1	—
	NP8-10ZS/24	●	1	—
	NP8-10ZS/25	●	1	—
	NP8-10ZS/26	●	1	—
	NP8-01ZS/21	○	—	1
	NP8-01ZS/22	●	—	1
	NP8-01ZS/23	●	—	1
	NP8-01ZS/24	●	—	1
	NP8-01ZS/25	●	—	1
	NP8-01ZS/26	●	—	1
	NP8-20ZS/21	○	2	—
	NP8-20ZS/22	●	2	—
	NP8-20ZS/23	●	2	—
	NP8-20ZS/24	●	2	—
	NP8-20ZS/25	●	2	—
	NP8-20ZS/26	●	2	—

NP8-□□ ZS/□□	Model	Color	↵	↶
	NP8-02ZS/21	○	—	2
	NP8-02ZS/22	●	—	2
	NP8-02ZS/23	●	—	2
	NP8-02ZS/24	●	—	2
	NP8-02ZS/25	●	—	2
	NP8-02ZS/26	●	—	2
	NP8-11ZS/21	○	2	1
	NP8-11ZS/22	●	2	1
	NP8-11ZS/23	●	2	1
	NP8-11ZS/24	●	2	1
	NP8-11ZS/25	●	2	1
	NP8-11ZS/26	●	2	1

Dimension (mm)

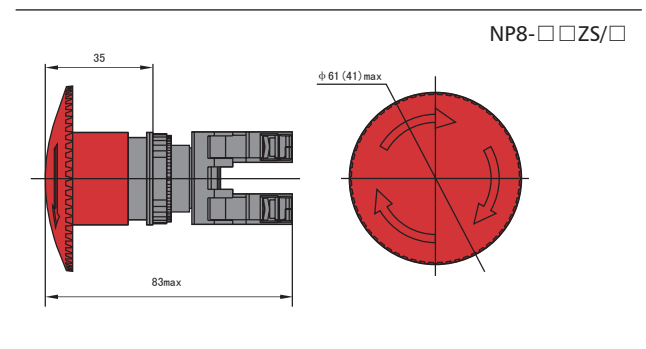

★ Double-headed flush momentary button (Non-illuminated)

NP8-□□ S	Lamp-Voltage	Model	Color	↵	↶
	Non-illuminated	NP8-20S	● + ●	2	—
		NP8-02S	● + ●	—	2
		NP8-11S	● + ●	1	1

★ Double-headed flush momentary button (Illuminated)

NP8-□□ SD	Lamp-Voltage	Model	Color	↵	↶
	LED: AC/DC 6V, 12V, 24V, 36V; AC 110V, 230V	NP8-20SD	● + ●	2	—
		NP8-02SD	● + ●	—	2
		NP8-11SD	● + ●	1	1

Dimension (mm)

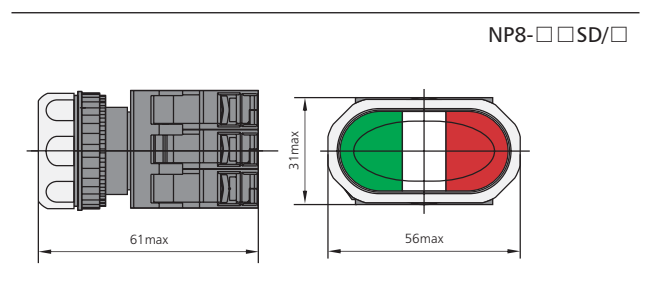
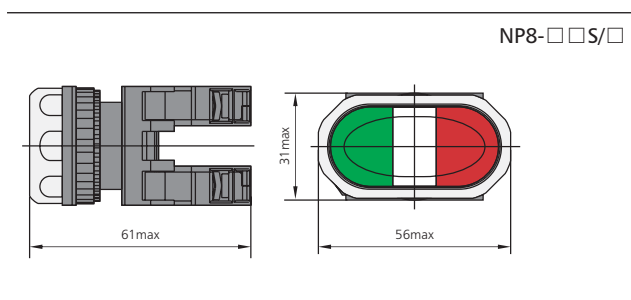



★ Indicator

NP8-D/ □	Lamp-Voltage	Model	Color
	LED: AC/AD 6V, 12V, 24V, 36V; AC110V, 230V	NP8-D/1	○
		NP8-D/3	●
		NP8-D/4	●
		NP8-D/5	●
		NP8-D/6	●

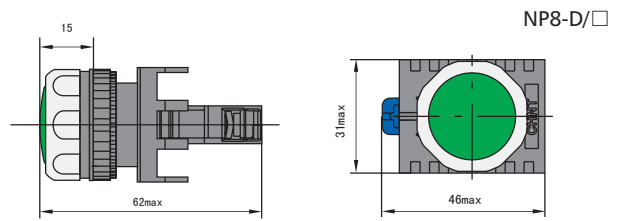
Dimension (mm)



★ Selector Switches (2 positions)-(Non-illuminated)

NP8- □□ X/ □	Metal	Color	Selector Switches	↖	↗	
	NP8-10X/211	○	↙	1	—	
	NP8-10X/212	●		1	—	
	NP8-10X/213	●		1	—	
	NP8-10X/214	●		1	—	
	NP8-10X/215	●		1	—	
	NP8-10X/216	●		1	—	
	NP8-01X/211	○	↘	—	1	
	NP8-01X/212	●		—	1	
	NP8-01X/213	●		—	1	
	NP8-01X/214	●		—	1	
	NP8-01X/215	●		—	1	
	NP8-01X/216	●		—	1	
		NP8-10X/221	○	↙	1	—
		NP8-10X/222	●		1	—
		NP8-10X/223	●		1	—
		NP8-10X/224	●		1	—
NP8-10X/225		●	1		—	
NP8-10X/226		●	1		—	
NP8-01X/221		○	↘	—	1	
NP8-01X/222		●		—	1	
NP8-01X/223		●		—	1	
NP8-01X/224		●		—	1	
NP8-01X/225		●		—	1	
NP8-01X/226		●		—	1	
		NP8-20X/211	○	↙	2	—
		NP8-20X/212	●		2	—
		NP8-20X/213	●		2	—
		NP8-20X/214	●		2	—
	NP8-20X/215	●	2		—	
	NP8-20X/216	●	2		—	
	NP8-02X/211	○	↘	—	2	
	NP8-02X/212	●		—	2	
	NP8-02X/213	●		—	2	
	NP8-02X/214	●		—	2	
	NP8-02X/215	●		—	2	
	NP8-02X/216	●		—	2	
	NP8-11X/211	○	↖	1	1	
	NP8-11X/212	●		1	1	
	NP8-11X/213	●		1	1	
	NP8-11X/214	●		1	1	
	NP8-11X/215	●		1	1	
	NP8-11X/216	●		1	1	

NP8- □□ X/22 □	Metal	Color	Selector Switches	↖	↗
	NP8-20X/221	○	↙	2	—
	NP8-20X/222	●		2	—
	NP8-20X/223	●		2	—
	NP8-20X/224	●		2	—
	NP8-20X/225	●		2	—
	NP8-20X/226	●		2	—
	NP8-02X/221	○	↘	—	2
	NP8-02X/222	●		—	2
	NP8-02X/223	●		—	2
	NP8-02X/224	●		—	2
	NP8-02X/225	●		—	2
	NP8-02X/226	●		—	2
	NP8-11X/221	○	↖	1	1
	NP8-11X/222	●		1	1
	NP8-11X/223	●		1	1
	NP8-11X/224	●		1	1
	NP8-11X/225	●		1	1
	NP8-11X/226	●		1	1

★ Selector Switches (3 positions)-(Non-illuminated)

NP8- □□ X/ □	Metal	Color	Selector Switches	↖	↗
	NP8-20X/311	○	↙	2	—
	NP8-20X/312	●		2	—
	NP8-20X/313	●		2	—
	NP8-20X/314	●		2	—
	NP8-20X/315	●		2	—
	NP8-20X/316	●		2	—
	NP8-02X/311	○	↘	—	2
	NP8-02X/312	●		—	2
	NP8-02X/313	●		—	2
	NP8-02X/314	●		—	2
	NP8-02X/315	●		—	2
	NP8-02X/316	●		—	2
	NP8-11X/311	○	↖	1	1
	NP8-11X/312	●		1	1
	NP8-11X/313	●		1	1
	NP8-11X/314	●		1	1
	NP8-11X/315	●		1	1
	NP8-11X/316	●		1	1

NP8-□□ X/33 □	Metal	Color	Selector Switches	Dimension (mm)	
				↵	↶
	NP8-20X/331	○		2	—
	NP8-20X/332	●		2	—
	NP8-20X/333	●		2	—
	NP8-20X/334	●		2	—
	NP8-20X/335	●		2	—
	NP8-20X/336	●		2	—
	NP8-02X/331	○		—	2
	NP8-02X/332	●		—	2
	NP8-02X/333	●		—	2
	NP8-02X/334	●		—	2
	NP8-02X/335	●		—	2
	NP8-02X/336	●		—	2
	NP8-11X/331	○		1	1
	NP8-11X/332	●		1	1
	NP8-11X/333	●		1	1
	NP8-11X/334	●		1	1
	NP8-11X/335	●		1	1
	NP8-11X/336	●		1	1
NP8-□□ X/37 □	Metal	Color	Selector Switches	↵	↶
	NP8-20X/371	○		2	—
	NP8-20X/372	●		2	—
	NP8-20X/373	●		2	—
	NP8-20X/374	●		2	—
	NP8-20X/375	●		2	—
	NP8-20X/376	●		2	—
	NP8-02X/371	○		—	2
	NP8-02X/372	●		—	2
	NP8-02X/373	●		—	2
	NP8-02X/374	●		—	2
	NP8-02X/375	●		—	2
	NP8-02X/376	●		—	2
	NP8-11X/371	○		1	1
	NP8-11X/372	●		1	1
	NP8-11X/373	●		1	1
	NP8-11X/374	●		1	1
	NP8-11X/375	●		1	1
	NP8-11X/376	●		1	1
NP8-□□ X/38 □	Metal	Color	Selector Switches	↵	↶
	NP8-20X/381	○		2	—
	NP8-20X/382	●		2	—
	NP8-20X/383	●		2	—
	NP8-20X/384	●		2	—
	NP8-20X/385	●		2	—
	NP8-20X/386	●		2	—
	NP8-02X/381	○		—	2
	NP8-02X/382	●		—	2
	NP8-02X/383	●		—	2
	NP8-02X/384	●		—	2
	NP8-02X/385	●		—	2
	NP8-02X/386	●		—	2
	NP8-11X/381	○		1	1
	NP8-11X/382	●		1	1
	NP8-11X/383	●		1	1
	NP8-11X/384	●		1	1
	NP8-11X/385	●		1	1
	NP8-11X/386	●		1	1

Dimension (mm)

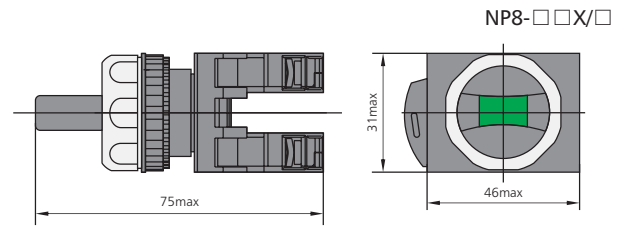

★ Selector Switches (2 positions) -(Illuminated)

NP8- □□ XD/ □	Metal	Color	Selector Switches	↙	↘	
	NP8-10XD/211	○	↙	1	—	
	NP8-10XD/213	●		1	—	
	NP8-10XD/214	●		1	—	
	NP8-10XD/215	●		1	—	
	NP8-10XD/216	●		1	—	
	NP8-01XD/211	○		—	1	
	NP8-01XD/213	●		—	1	
	NP8-01XD/214	●		—	1	
	NP8-01XD/215	●		—	1	
NP8-01XD/216	●	—	1			
	NP8-10XD/221	○	↘	1	—	
	NP8-10XD/222	●		1	—	
	NP8-10XD/223	●		1	—	
	NP8-10XD/224	●		1	—	
	NP8-10XD/225	●		1	—	
	NP8-10XD/226	●		1	—	
	NP8-01XD/221	○		—	1	
	NP8-01XD/22	●		—	1	
	NP8-01XD/23	●		—	1	
	NP8-01XD/24	●		—	1	
	NP8-01XD/25	●		—	1	
	NP8-01XD/26	●		—	1	
		NP8-20XD/211		○	↙	2
NP8-20XD/213		●	2	—		
NP8-20XD/214		●	2	—		
NP8-20XD/215		●	2	—		
NP8-20XD/216		●	2	—		
NP8-02XD/211		○	—	2		
NP8-02XD/213		●	—	2		
NP8-02XD/214		●	—	2		
NP8-02XD/215		●	—	2		
NP8-02XD/216		●	—	2		
NP8-11XD/211		○	1	1		
NP8-11XD/213		●	1	1		
NP8-11XD/214		●	1	1		
NP8-11XD/215	●	1	1			
NP8-11XD/216	●	1	1			
	NP8-20XD/221	○	↘			
	NP8-20XD/222	●				
	NP8-20XD/223	●				
	NP8-20XD/224	●				
	NP8-20XD/225	●				
	NP8-20XD/226	●				
	NP8-02XD/221	○				
	NP8-02XD/222	●				
	NP8-02XD/223	●				
	NP8-02XD/224	●				
	NP8-02XD/225	●				
	NP8-02XD/226	●				
	NP8-11XD/221	○		1	1	
	NP8-11XD/222	●		1	1	
	NP8-11XD/223	●		1	1	
	NP8-11XD/224	●		1	1	
	NP8-11XD/225	●		1	1	
	NP8-11XD/226	●		1	1	

★ Selector Switches With key (2 positions)-(Non-illuminated)

NP8-□□ Y/□	Metal	Selector Switches	↙	↘
	NP8-10Y/21	↙	1	—
	NP8-01Y/21		—	1
	NP8-10Y/22	↘	1	—
	NP8-01Y/22		—	1
	NP8-20Y/21	↙	2	—
	NP8-02Y/21		—	2
	NP8-11Y/21		1	1
	NP8-20Y/22	↘	2	—
	NP8-02Y/22		—	2
	NP8-11Y/22		1	1

★ Selector Switches (3 positions) -(Illuminated)

NP8- □□ XD/ □	Metal	Color	Selector Switches	↙	↘	
	NP8-20XD/311	○	↙	2	—	
	NP8-20XD/313	●		2	—	
	NP8-20XD/314	●		2	—	
	NP8-20XD/315	●		2	—	
	NP8-20XD/316	●		2	—	
	NP8-02XD/311	○		—	2	
	NP8-02XD/313	●		—	2	
	NP8-02XD/314	●		—	2	
	NP8-02XD/315	●		—	2	
	NP8-02XD/316	●		—	2	
	NP8-11XD/311	○		1	1	
	NP8-11XD/313	●		1	1	
	NP8-11XD/314	●		1	1	
	NP8-11XD/315	●		1	1	
	NP8-11XD/316	●		1	1	

NP8-□□ XD/33□	Metal	Color	Selector Switches	Selector Switches	
				↙	↘
	NP8-20XD/331	○		2	—
	NP8-20XD/332	●		2	—
	NP8-20XD/333	●		2	—
	NP8-20XD/334	●		2	—
	NP8-20XD/335	●		2	—
	NP8-20XD/336	●		2	—
	NP8-02XD/331	○		—	2
	NP8-02XD/332	●		—	2
	NP8-02XD/333	●		—	2
	NP8-02XD/334	●		—	2
	NP8-02XD/335	●		—	2
	NP8-02XD/336	●		—	2
	NP8-11XD/331	○		1	1
	NP8-11XD/332	●		1	1
	NP8-11XD/333	●		1	1
	NP8-11XD/334	●		1	1
	NP8-11XD/335	●	1	1	
	NP8-11XD/336	●	1	1	
NP8-□□ XD/37□	Metal	Color	Selector Switches	Selector Switches	
				↙	↘
	NP8-20XD/371	○		2	—
	NP8-20XD/372	●		2	—
	NP8-20XD/373	●		2	—
	NP8-20XD/374	●		2	—
	NP8-20XD/375	●		2	—
	NP8-20XD/376	●		2	—
	NP8-02XD/371	○		—	2
	NP8-02XD/372	●		—	2
	NP8-02XD/373	●		—	2
	NP8-02XD/374	●		—	2
	NP8-02XD/375	●		—	2
	NP8-02XD/376	●		—	2
	NP8-11XD/371	○		1	1
	NP8-11XD/372	●		1	1
	NP8-11XD/373	●		1	1
	NP8-11XD/374	●		1	1
	NP8-11XD/375	●	1	1	
	NP8-11XD/376	●	1	1	
NP8-□□ XD/38□	Metal	Color	Selector Switches	Selector Switches	
				↙	↘
	NP8-20XD/381	○		2	—
	NP8-20XD/382	●		2	—
	NP8-20XD/383	●		2	—
	NP8-20XD/384	●		2	—
	NP8-20XD/385	●		2	—
	NP8-20XD/386	●		2	—
	NP8-02XD/381	○		—	2
	NP8-02XD/382	●		—	2
	NP8-02XD/383	●		—	2
	NP8-02XD/384	●		—	2
	NP8-02XD/385	●		—	2
	NP8-02XD/386	●		—	2
	NP8-11XD/381	○		1	1
	NP8-11XD/382	●		1	1
	NP8-11XD/383	●		1	1
	NP8-11XD/384	●		1	1
	NP8-11XD/385	●	1	1	
	NP8-11XD/386	●	1	1	

Dimension (mm)

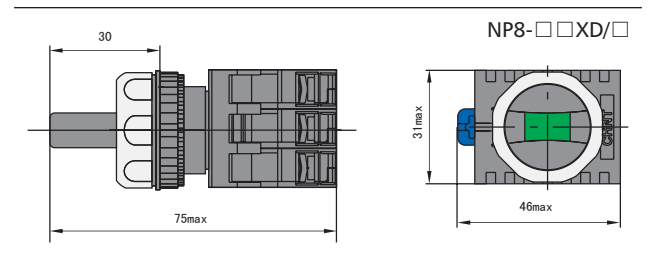

★ Selector Switches With key (3 positions)-(Non-illuminated)

NP8-□□ Y/□	Metal	Selector Switches	Selector Switches	
			↙	↘
	NP8-20Y/31		2	—
	NP8-02Y/31		—	2
	NP8-11Y/31		1	1
NP8-□□ Y/33	Metal	Selector Switches	Selector Switches	
			↙	↘
	NP8-20Y/33		2	—
	NP8-02Y/33		—	2
	NP8-11Y/33		1	1
NP8-□□ Y/37	Metal	Selector Switches	Selector Switches	
			↙	↘
	NP8-20Y/37		2	—
	NP8-02Y/37		—	2
	NP8-11Y/37		1	1
NP8-□□ Y/38	Metal	Selector Switches	Selector Switches	
			↙	↘
	NP8-20Y/38		2	—
	NP8-02Y/38		—	2
	NP8-11Y/38		1	1

Dimension (mm)

